



CL555

Amplified Big Button Telephone And Answering Machine



English

!!! Please refer to our website:
www.geemarc.com for an up to date user guide,
as there may be important updates and changes
you need to be aware of !!!

CONTENTS

CONTENTS	2
INTRODUCTION	5
Unpacking the Telephone.....	6
DESCRIPTION and General Description	7
Key Description	9
LCD Description	10
Menu Navigation.....	11
INSTALLATION and Setting Up	12
Wall Mounting.....	12
SETTINGS	13
Set Language	13
Set Contrast.....	13
Night Light Function.....	14
Set Font Size	14
Hour Format Setting	15
Date Format Setting	15
Ringer Setting.....	16
Incoming Call Notification Setting	17
Keypad Tones Setting	17
Call Waiting	18
Flash Time Setting.....	19
Dialling Mode Setting.....	19
Setting Date and Time	20
Dialling Talking Setting	21
Caller ID Talking Setting.....	21
Review the Phonebook and Caller ID List	22
Voice Prompt.....	22
Receiving Volume and Tone Settings.....	23
USING THE TELEPHONE and Making a Call	25
Last Number Redial.....	26
Dialling a Number from the Redial List	26

CONTENTS

Clear the Redial List	26
Mute Function	27
Hold Function	27
Receiving a Call.....	28
Hearing Aid Use	28
Flash Signal.....	28
OPTIONAL ACCESSORIES	29
Shaker	29
Headset and Audio Neck Loop Use.....	29
CALLER ID	30
View Caller ID List	30
Dial a Number from the Caller ID List	31
Add a Number from the Caller ID List to the Phone book.....	31
Delete a Number from the Caller ID List.....	32
Delete all Numbers from the Caller ID List	32
Caller ID on Call Waiting	32
PHONE BOOK	33
Create a Phone Book Entry in Standby Mode	33
View Phone Book Entries	35
Dial a Phone Book Entry	35
Modify a Phone Book Entry	35
Delete a Phone Book Entry	36
Voice Announce a Phonebook Entry	36
Record Voice Announce for a Phonebook Entry	37
Delete Voice Announce for a Phonebook Entry.....	37
QUICK DIAL.....	38
Create a Quick Dial Number.....	38
View/Dial a Quick Dial Number.....	39
Clear a Quick Dial Number.....	39
ANSWERING MACHINE.....	40
Switching the Answering Machine On/Off	40

CONTENTS

The Outgoing Message	41
Recording an Outgoing Message	41
Checking an Outgoing Message.....	42
Restore the Outgoing Message	43
Answering Machine Settings	44
Listening to Messages	45
Call Screening	45
Incoming Message Voice Slow.....	46
Operating the Answering Machine Remotely.....	46
Remote Code	46
Remote Control	47
Remote Control Commands	47
Recording a Memo	48
Out of Memory.....	48
TROUBLESHOOTING	49
SAFETY INFORMATION	50
GUARANTEE.....	51
RECYCLING DIRECTIVES.....	53

INTRODUCTION

Congratulations on purchasing your Geemarc CL555. This is a multifunction telephone which offers features such as hands free use, caller ID*, caller announce, dialling talking, a phone book, quick dial and an answering machine. It offers amplification, helpful for those with hearing difficulties. It has a large button, easy to see and use keypad, to help stop any misdialling. This telephone is compatible with hearing aids.

It is important that you read the instructions below in order to use your Geemarc telephone to its full potential. Keep this user guide in a safe place for future reference.

This guide explains how to use the following telephone:

CL555

*To use the caller display facility, you must subscribe to your network provider's caller display service.

INTRODUCTION

Unpacking the Telephone

When unpacking the telephone, you should find the following in the box:

- 1 CL555 unit
- 1 CL555 handset with curly cord
- 1 Telephone line cord
- 1 Mains power adaptor
- 1 User Guide







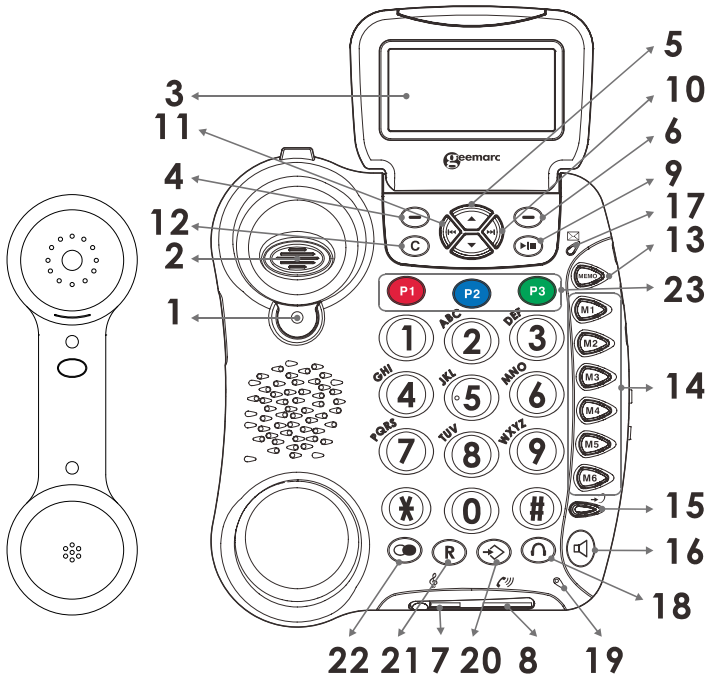

For product support and help visit our website at

www.geemarc.com
telephone **01707 387602**
or fax **01707 832529**

DESCRIPTION

General Description



- | | |
|--------------------------------|--|
| 1. Handset Knob | 13. MEMO |
| 2. Hook Switch | 14. Speed Dial Key (M1-M6) |
| 3. Large LCD Screen | 15. Additional Amplifier key/indicator  |
| 4. Left Soft Key | 16. Speaker Key  |
| 5. Up/Down Scroll | 17. Message waiting/new call LED |
| 6. Right Soft Key | 18. Headset Key  |
| 7. Tone reception Adjustment | 19. Microphone |
| 8. Volume reception Adjustment | 20. Store Key  |
| 9. Play/Stop | 21. R Key |
| 10. Next | 22. Redial Key  |
| 11. Previous | 23. Emergency Speed Dial (P1-P3) |
| 12. DEL (C) | |



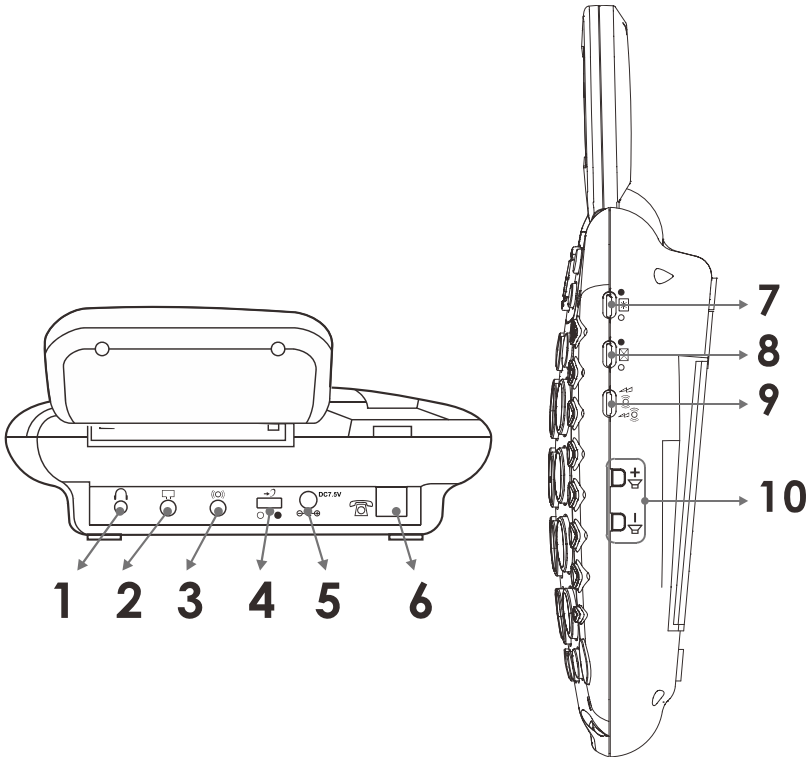









DESCRIPTION

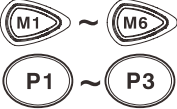

1. Headset jack
2. Audio neckloop jack
3. Optional Bed Shaker jack
4. Volume Reset Override Switch (ON/OFF)
5. Power jack
6. Phone Line Cord jack
7. Back Light Switch
8. New Call Indicator Switch
9. Shaker/Strobe/Strobe and Shaker Select Mode
10. Volume controls

DESCRIPTION

Key Description

	<p>Make/Answer/End a call. Activates the speakerphone if pressed during a call</p>
	<p>Last number redial Insert a pause when pre-dialing a number</p>
	<p>Scroll through the menu options. Enter the Caller ID list</p>
	<p>Soft keys. They perform the functions indicated by the text immediately over it (on the bottom line of the display) which changes depending on context</p>
	<p>Press this button to turn the extra amplification ON or OFF</p>
	<p>The nine keys are used as one-touch speed dial keys</p>
	<p>This key is used to store numbers</p>
	<p>This button is used to disconnect a call and re-establish dial tone or to switch over to another caller provided you have requested these services i.e. call waiting from your service provider</p>
	<p>Press to start or stop the Message or Memo playing.</p>
	<p>Press to play the next message</p>
	<p>Press once to play the current message. Press twice to play the previous message</p>
	<p>When playing a message press this key to delete the current message.</p>
	<p>Press and hold this key to record a memo</p>
	<p>Use them to adjust the volume of ringer, dialing talking, Caller ID announcing and speakerphone</p>

DESCRIPTION

LCD Description

In standby mode, the large LCD display will show as below

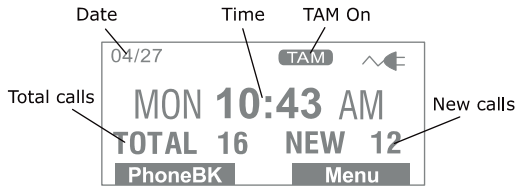

If you forget to connect the phone line cord, **No line** will show on the screen



When you press the **Menu** soft key, the main menu will be displayed. Use **▲** or **▼** to scroll through the menu until you find the desired option. Press the **select** soft key to confirm.

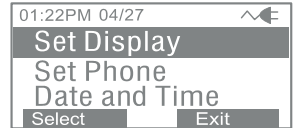

On receiving an incoming call, the caller's phone number and/or name will be displayed (providing you have subscribed to the Caller ID service with your network provider).

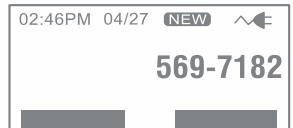

The screen below shows the total calls and new calls needing reviewing. In this example you have 16 calls in total, which includes 12 new calls.



The screen below shows that you have 2 new answer machine messages.



If you subscribe to a Caller ID service -If the caller has exercised the option to prevent their name and number from being sent, **Private** will be shown on the display.

If you subscribe to a Caller ID service – **Out of Area** will display when someone calls from an area where the telephone company is not offering the caller identification services or is not yet providing number delivery to your area.

DESCRIPTION

Menu Navigation

To access any menu function you must take the following steps:

- 1) Press the **Menu** soft key, the main menu will be displayed.
- 2) Use ▲ or ▼ to scroll through the menu until you find the desired option.
- 3) Press the **Select** soft key to confirm.

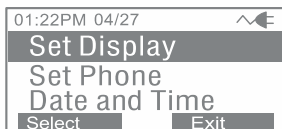

To exit any menu you must take the following step:

- 1) Press the **back** or the **exit** soft key, the phone will return to the previous screen.

Menu Map

Set Display	
	Set Language
	Set Contrast
	Dim:X---x
	Hour Format
	Date Format
Set Phone	
	Set Ring
	Call Waiting
	Set Flash
	Dialling Mode
Date and Time	
Set Talk	
	Dialling Talking
	CID Talking
	Review Talking
	Voice Prompt
TAM Setup	
	TAM ON/OFF
	Outgoing Msg
	Ring Number
	Security ID
	ICM Voice Slow

INSTALLATION

Setting Up

Connect one end of the curly cord to the handset. The other end of the curly cord plugs into the jack on the left hand side of the CL555 unit. Place the handset on the cradle.

Connect the line cord to the socket located at rear of telephone then connect the plug into the wall socket **.

For the LCD display, backlight and other special features you must insert the power adapter. Connect the power adaptor to the jack located at the rear of the telephone then plug the other end into a 13amp wall socket (*). Please choose a socket near your telephone to enable you to unplug the mains power quickly in case of a problem.

(*) Classified "hazardous voltage" according to EN60950 standard

(**) Classified TNV-3 according to EN60950 standard.

Wall Mounting

Turn the handset hanger clockwise and reverse its position (rotate it 180 degrees - see diagram 1). This will keep the handset from falling out of the cradle when it is mounted on the wall.

Knock two self-tapping screws (not supplied) into a wall at a distance of 80 mm from each other and placed in a vertical line.

Place the phone onto the screw-heads and slide down to secure (see diagram 2).

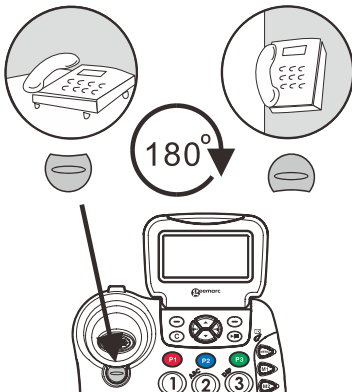

Diagram 1

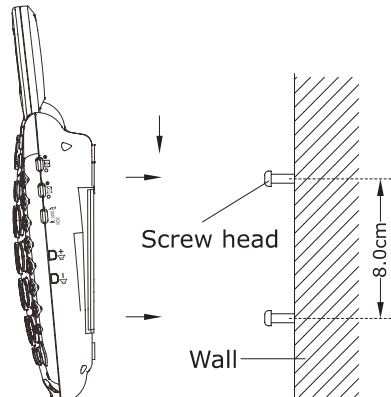

Diagram 2

SETTINGS

Set Language

Press **'MENU'** soft key

Press **'SELECT'** soft key to access **'SET
DISPLAY'**

Press **'SELECT'** soft key to access **'LANGUAGE'**

Use ▲ and ▼ to select one of the 6 languages available
(English, Francais, Espanol, Deutsch, Italian, Dutch)

Press **'SELECT'** soft key to confirm

Set Contrast

Your screen has a backlight which automatically switches off after 15 seconds of inactivity. The contrast of the backlight against the text can be increased or decreased.

Press **'MENU'** soft key

Press **'SELECT'** soft key to access **'SET
DISPLAY'**

Use ▲ and ▼ to select **'SET CONTRAST'**



Press **'SELECT'** soft key

Use ▲ and ▼ to select one of the 8 contrast levels
available

Press **'SELECT'** soft key to confirm

SETTINGS

Night Light Function

If you wish to use the LCD back light as a night light, switch the back light switch  to . In doing so the back light will be switched on constantly.

Set Font size

The text can be displayed on the LCD screen in either a large font or a small font.

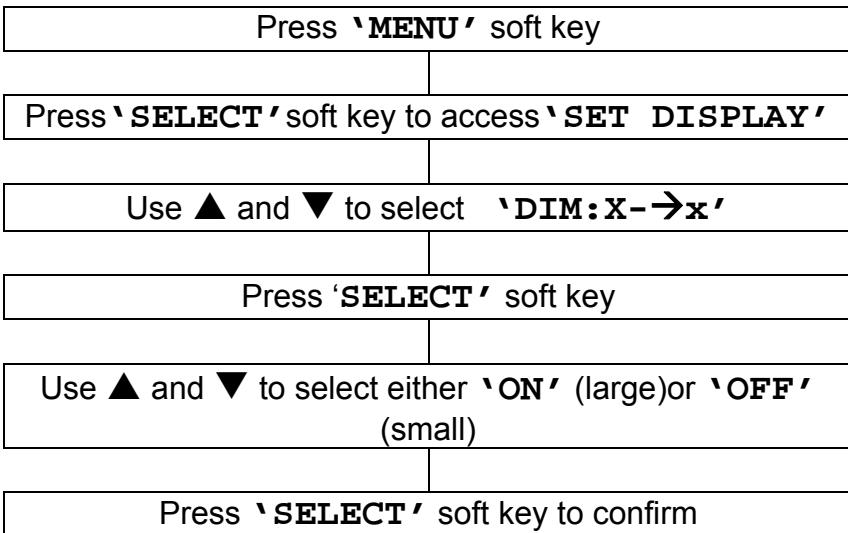

Note: If large font is 'ON', when you pre-dial a number – if the telephone number exceeds 8 digits, the font will be switched to the smaller size automatically.

SETTINGS

Hour Format Setting

Press **'MENU'** soft key

Press **'SELECT'** soft key to access **'SET DISPLAY'**

Use ▲ and ▼ to select **'HOUR FORMAT'**

Press **'SELECT'** soft key

Use ▲ and ▼ to select either **'12 HOUR CLOCK'** or **'24 HOUR CLOCK'**

Press **'SELECT'** soft key to confirm

Note: If 12 hour clock is selected, AM or PM will be displayed on the right hand side of the time in standby mode.

Date Format Setting

Press **'MENU'** soft key

Press **'SELECT'** soft key to access **'SET DISPLAY'**

Use ▲ and ▼ to select **'DATE FORMAT'**

Press **'SELECT'** soft key

Use ▲ and ▼ to select either **'MM/DD'** or **'DD/MM'**

Press **'SELECT'** soft key to confirm

SETTINGS

Ringer Setting

You can select your own ring tone and adjust both the day volume and night volume. You can also adjust the volume to off in order to turn the ringer off.

Press **'MENU'** soft key

Use **▲** and **▼** to select **'SET PHONE'**

Press **'SELECT'** soft key

Use **▲** and **▼** to select **'SET RING'**, press **'SELECT'**

'Ringer VOLUME' will be displayed on the LCD display

Use **▲** and **▼** to select the desired volume among the 5 positions and the **'OFF'** will be displayed and the phone will ring at the selected volume level

Press **'SELECT'** soft key

Use **▼** to select **'RING TONE'**

Press **'SELECT'** soft key

Use **▲** and **▼** to select the desired ring tone. Each time you change the tone melody, the phone rings with the selected ring tone.

Press **'SELECT'** soft key

You can also adjust the ringer volume whilst in standby. Simply use the volume controls VOL+ and VOL- found on the right hand side of the telephone. The display will show the current level. For example: **'Volume 2'**.

SETTINGS

Incoming Call Notification Setting

There is a Shaker/Strobe/Shaker and Strobe select switch on the right hand side of the telephone. This allows you to choose the way you wish to be notified of an incoming call. There is the adjustable ringer, a bright strobe that flashes on receiving a call and finally a bed shaker. You can choose one of these options or any combination of the three. If you have purchased the optional bed shaker, simply plug into the shaker jack and place it between your mattress and box spring.

Keypad Tones Setting

Press **'MENU'** soft key

Use ▲ and ▼ to select **'SET PHONE'**

Press **'SELECT'** soft key

Press **'SELECT'** soft key to access **'SET RING'**

Use ▲ and ▼ to select **'KEYPAD TONES'**

Press **'select'** soft key to set the keypad tones.
You can choose either **'ON'**, **'OFF'**

Press **'select'** soft key to confirm

Note: Link to ringer means the keypad tones will be heard at the same volume as the ringer volume. Any changes made to the ringer volume will automatically update the keypad tone volume.

SETTINGS

Call Waiting

If you subscribe to Call Waiting service from your service provider, you should activate the Call Waiting function on the telephone. The telephone will display the name (provided the name and number are stored in the phonebook) and number of a second caller while you are having a conversation.

Press **'MENU'** soft key

Use ▲ and ▼ to select **'SET PHONE'**

Press **'SELECT'** soft key

Use ▲ and ▼ to select **'CALL WAITING'**

Press **'SELECT'** soft key

Use ▲ and ▼ to select **'ON'** or **'OFF'** to activate the call waiting function

Press **'SELECT'** soft key to confirm

SETTINGS

Flash Time Setting

You can adjust the flash time setting. There are four options available. Your telephone works with a flash time for United Kingdom (R=100ms).

Press **'MENU'** soft key

Use **▲** and **▼** to select **'SET PHONE'**

Press **'SELECT'** soft key

Use **▲** and **▼** to select **'SET FLASH'**

Press **'SELECT'** soft key

Use **▲** and **▼** to select either **'100ms'**, **'300ms'** or **'600ms'**

Press **'SELECT'** soft key to confirm

Dialling Mode Setting

In the UK, all telephone exchanges now use Tone dialing. If your telephone does not dial out, it is probably being used from an older private switch-board (PBX). In this case, the Tone/Pulse setting must be changed to Pulse.

Press **'MENU'** soft key

Use **▲** and **▼** to select **'SET PHONE'**

Press **'SELECT'** soft key

Use **▲** and **▼** to select **'DIALLING MODE'**

Press **'SELECT'** soft key

Use **▲** and **▼** to select either **'TONE'** or **'PULSE'**

Press **'SELECT'** soft key to confirm

SETTINGS

Setting Date and Time

In standby mode, the telephone displays the current date and time. You need to set the date and time so that when you receive calls they will appear in the call list with the correct date and time. If you subscribe to a Caller ID service, the time and date will be set automatically when you receive your first call.

Press **'MENU'** soft key

Use ▲ and ▼ to select **'SET time and Date'**

Press **'SELECT'** soft key

Enter the correct time using the numeric keypad

Press **'SAVE'** soft key

Enter the correct date using the numeric keypad

Press **'SAVE'** soft key

Enter the correct year using the numeric keypad

Press **'SAVE'** soft key

SETTINGS

Dialling Talking Setting

This feature allows you to check the number you have entered in standby mode without looking at the display i.e. the number is announced when pressed.

Press **'MENU'** soft key

Use **▲** and **▼** to select **'SET TALK'**

Press **'SELECT'** soft key

Press **'SELECT'** soft key to access **'DIALLING TALKING'**

Use **▲** and **▼** to select either **'ON'** or **'OFF'** to activate/deactivate the dialling talking function

Press **'SELECT'** soft key to confirm

Caller ID Talking Setting

This feature allows you to check the Caller ID number on receiving a new call without looking at the display i.e. the telephone number is announced (provided the number has not been blocked by the caller). If you have stored the incoming telephone number in the phone book and recorded the corresponding name, the name will be announced.

Press **'MENU'** soft key

Use **▲** and **▼** to select **'SET TALK'**

Press **'SELECT'** soft key

Use **▲** and **▼** to select **'CID TALKING'**

Use **▲** and **▼** to select either **'ON'** or **'OFF'** to activate/deactivate the Caller ID talking function

Press **'SELECT'** soft key to confirm

SETTINGS

Review the Phonebook and Caller ID List

The telephone can announce numbers stored in the phonebook and the Caller ID list (except Private and Out of Area calls). If a name is stored with a telephone number, the name will be announced.

Press **'MENU'** soft key

Use ▲ and ▼ to select **'SET TALK'**

Press **'SELECT'** soft key

Use ▲ and ▼ to select **'REVIEW TALKING'**

Use ▲ and ▼ to select either **'ON'** or **'OFF'** to activate/deactivate the review talking function

Press **'SELECT'** soft key to confirm

Voice Prompt

You can select the language in which to play the voice prompt.

Press **'MENU'** soft key

Use ▲ and ▼ to select **'SET TALK'**

Press **'SELECT'** soft key

Use ▲ and ▼ to select **'VOICE PROMPT'**

Use ▲ and ▼ to select the required language (English, Deutsch, Francais, Italian or Dutch)

Press **'SELECT'** soft key to confirm

SETTINGS

Receiving Volume and Tone Settings

You can alter the receiving volume and tone during a conversation according to your hearing requirements.

Use the Volume slide control found at the front of the telephone base to adjust the level. The volume adjustment available is 0-25dB.

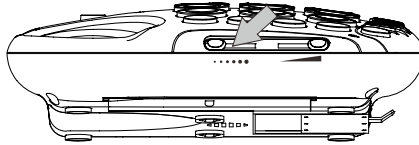

The → button on the telephone base provides additional amplification of 25dB i.e the volume adjustment available is 25-50B. When the amplify function is activated, the Amplify LED is lit.

Setting a default for Amplification.

The Amplify **ON /OFF** (↻) located at the rear allows the amplification facility to be switched ON or OFF as a default each time you use the telephone.

AMPLIFY ON/OFF Switch at ON Position (↻)

The additional amplification and tone controls are automatically activated each time you use the telephone. The amplify LED light will be lit when you use the telephone.

Pressing the Amplify key (→↻) during a call will turn off the additional amplification and tone controls. However, you can still adjust the handset receive volume with the Volume slide bar.

Irrespective of how many times you press the Amplify key (→↻) throughout a call, the next time you pick up the handset to make a new call, these functions will be activated once again.

SETTINGS

AMPLIFY ON/OFF Switch at OFF Position (📞)

The additional amplification and tone controls are turned off each time you use the telephone. The Amplify LED will be off whenever you use the telephone.

Pressing the Amplify key (→📞) once during a call will enable tone control and additional amplification. The LED light will turn on to reflect this change. If you press the Amplify key (→📞) once more, the additional amplification and tone control features will be turned off once again. The LED light will turn off to reflect this change.

Irrespective of how many times you press the Amplify key (→📞) throughout a call, the next time you pick up the handset, these functions will be turned off once again.

Tone Receiving Adjustment

If the receiver volume has been amplified, the tone control can also be adjusted. You can adjust and increase the low frequency or high frequency sounds with the tone slide control on the top of the unit.



Note: The tone adjustment function will not be effective when the amplify feature is not being used

USING THE TELEPHONE





Making a Call

Pick up the handset.

When you hear the dialling tone, dial the number on the keypad.

To end the call simply replace the handset in the cradle

Making a Call – Hands Free

Press the  button to get a dialling tone then dial the telephone number on the keypad. The  icon appears on the LCD. To end the call, simply press  again. The  icon will disappear.

To activate the Hands Free function during the call, press the  button and replace the handset on the cradle at the same time.

To deactivate the Hands Free function during a call, lift the handset.

Note: When in hands free mode, only one person may talk at a time. The switch-over between speaker and microphone is automatic. This is dependent on the sound level of the incoming call and the microphone respectively. It is therefore essential that there are no loud noises, e.g. music, in the immediate vicinity of the telephone, as this will disrupt the hands free function.

Speakerphone Volume Setting

In hands free mode you can adjust the speaker volume by using the volume controls VOL+ or VOL- located on the right side of the phone.

USING THE TELEPHONE

Pre-Dialling a Telephone Number

You can enter the desired phone number in standby mode, which allows you to make corrections before dialling. Follow these steps:

Enter a telephone number. Check it. If you make a mistake while entering a number, press the 'CLEAR' soft key to edit it.

When the number appears correctly, lift the handset or press the  button.



Last Number Redial

Lift the handset or press  for hands free use

Press  to redial the last number dialled. For this function, the phone number must be a maximum of 17 digits else the phone number is not kept.

Dialling a Number from the Redial List

Press  whilst in standby mode

Use  and  to scroll through the redial list to find the desired number

Lift the handset or press  for hands free use

Clear the Redial List

Press  whilst in standby mode

Press **Options** soft key, choose "Erase All" and press **Select** soft key to confirm. The LCD will display 'EMPTY LIST' to indicate that all the entries in the redial list have been deleted

USING THE TELEPHONE

Mute Function

If you wish, you can speak privately to someone else in the room without your caller overhearing. You will still be able to hear the caller but they cannot hear you during the mute operation.

To switch on the mute mode during a call press the **'MUTE'** soft key (**'MUTE'** will be displayed on the LCD). Your caller will not be able to hear you anymore. Press **'UNMUTE'** soft key to resume the conversation with your caller (**'MUTE'** will no longer be displayed on the LCD).

Hold Function

You can put a call on hold. Do this by simply pressing the **'HOLD'** soft key during a call. The LCD will display **'CALL ON HOLD'**. If you hang up now, the call will not be disconnected.

To continue the conversation, simply pick up the handset or press the **'UNHOLD'** soft key.

USING THE TELEPHONE

Receiving a Call

When an incoming call is received, the telephone rings and the incoming call indicator lights up.

Lift the handset and speak

To end the call simply replace the handset in the cradle

Receiving a call – Hands Free

Press  to speak hands free

To end the call press 

Hearing Aid Use

This telephone is hearing aid compatible. Select the T mode on your hearing aid to enable this feature.

Flash Signal

The R button can be used with special services such as Call Waiting (if provided by your service provider) or transferring external calls to another extension within a private switchboard.

OPTIONAL ACCESSORIES



Shaker

At the rear of the telephone, there is a 3.5mm shaker jack ((O)). You can connect an optional shaker device. When you are receiving an incoming call, the shaker will vibrate. (See Incoming Call Notification Settings)

Headset and Audio Neck Loop Use

Your phone is equipped with both an Audio and Headset jack at the rear of the telephone. Both the two jacks are amplified, allowing you to adjust both the tone and volume.

The Audio Neckloop jack allows you to listen through your Neckloop whilst speaking into the handset or the speakerphone

The Headset jack allows you to listen and speak through your hands free headset. Connect the headset at the rear side of the base in the 2.5mm jack . Press  to get a dial tone

CALLER ID

The features described in this section are only available if you subscribe to a Caller ID service from your network provider. Caller ID means you can see who is calling on your handset display (provided the number is not withheld, unavailable or is an international call).

The display shows '**PRIVATE**' for a withheld number.

The display shows '**Out of Area**' when someone calls from an area where the telephone company is not offering caller identification services or is not yet providing number delivery to your area.

Whether you take a call or not, the caller's telephone number/name together with the date and time of the call are stored in the Caller ID list. This book stores the last 20 incoming calls of up to 15 digits.

The New Call LED will flash to notify you of a new call. If you do not want the New Call LED to be lit to notify you of a new call, switch the new call indicator switch  (found on the right side of the unit) to Off.

View Caller ID List

Use ▲ and ▼ to scroll through the Caller ID list. The numbers will be listed in the order they were received. Scrolling through this list in order to review any new calls sets the New Call count to zero and the New Call LED will be switched off

CALLER ID

Dial a Number from the Caller ID List

Use ▲ and ▼ to scroll through the Caller ID list until you find the desired number

Pick up the handset or press the  key, the number is automatically dialed. (If the number is 10 or 11 digits, you can add or remove a 1 from in front of the number. E.g. if the original number in the Caller ID list was 800-965-9043, press the * key repeatedly to change it to 1-800-965-9043 or 965-9043. Or if the number is 1-987-654-3210, press the key *repeatedly to change it to 987-654-3210 or 654-3210)

Add a Number from the Caller ID List to the Phone Book

Use ▲ and ▼ to scroll through the Caller ID list until you find the number you wish to add to the phone book

Press **'OPTIONS'** soft key

Use ▲ and ▼ to select **'STORE'**

'NUMBER: ' will be displayed

Modify the phone number if it is not correct with the function **'CLEAR'**

'NAME: ' will be displayed

Enter the Name you wish using the numeric keypad function **'CLEAR'**

Press **'SAVE'** soft key to confirm

Use ▲ and ▼ to select the desired ring tone. Each time you change the tone melody, the phone rings with the selected ring tone.

CALLER ID

Press **'Select'** soft key to confirm

Delete a Number from the Caller ID List

Use **▲** and **▼** to scroll through the Caller ID list until you find the number you wish to delete from the Caller ID list

Press **'OPTIONS'** soft key

Use **▲** and **▼** to select **'ERASE'**

Delete All Numbers from the Caller ID List

Use **▲** and **▼** to enter the Caller ID list

Press **'OPTIONS'** soft key

Use **▲** and **▼** to select **'ERASE ALL'**

'ERASE ALL?' will be displayed

Select **'YES'** to confirm or **'NO'** to cancel

By deleting all the numbers in the Caller ID list, the Total Call count will be set to zero

Caller ID on Call Waiting

When you are using the telephone, if you have subscribed to Call Waiting with your service provider, the name and number of a second caller will be displayed.

Press the **R** key and **'2'** to answer the second caller.

When you have finished with the second caller, press **R** and **'2'** again to resume conversation with the original caller.

PHONE BOOK

Telephone numbers can be stored in the phone book. It allows you to store frequently used numbers so that you can easily make a call without having to remember or enter the telephone number. The phone book can contain **30** entries. Each phone number can contain up to **24** digits.

Create a Phone Book Entry in Standby Mode

Enter a telephone number whilst in standby

Press '**SAVE**' soft key

'**NUMBER:**' will be displayed

Modify the phone number if it is not correct with the function '**CLEAR**'

Press '**SAVE**' soft key to confirm

'**NAME:**' will be displayed

Enter the name you wish using the numeric keypad

Press '**SAVE**' soft key to confirm

Use ▲ and ▼ to select the desired ring tone. Each time you change the tone melody, the phone rings with the selected ring tone.

Press '**select**' soft key to confirm

PHONE BOOK

Note: If you make a mistake while entering a name or number, press **'CLEAR'** soft key to clear the last character/digit and then enter the correct character/digit. If a voice prompt is recorded with a phonebook entry, an icon will be displayed alongside the name.

Insert Pause

Inserting a pause provides a delay of 3 seconds. This is necessary with some telephone systems.

To insert a dialling pause between numbers when storing a number, press  until **'P'** appears in the LCD display

Character Map

Key	Characters in order				
0	0				.
1	Space	_	*	,	1
2	Aa	Bb	Cc	(2
3	Dd	Ee	Ff)	3
4	Gg	Hh	li	#	4
5	Jj	Kk	Ll	/	5
6	Mm	Nn	Oo	'	6
7	Pp	Qq	Rr	Ss	7
8	Tt	Uu	Vv	?	8
9	Ww	Xx	Yy	Zz	9

When entering letters, you can shift between upper and lower case by pressing * key. If you need to enter the same letter twice or another letter with the same key, wait a few seconds and the cursor will move automatically to the next space.

PHONE BOOK

View Phone Book Entries

Press **'PHONEBK'** soft key to enter the phone book

Use ▲ and ▼ to scroll through the phone book until you find the contact you wish to view. If the Review Talking feature is activated, the number (or name-if recorded) of the highlighted entry will be announced

Dial a Phone Book Entry

Press **'PHONEBK'** soft key to enter the phone book

Use ▲ and ▼ to scroll through the phone book until you find the contact you wish to dial

Pick up the handset or press the  key, the number is automatically dialed

Modify a Phone Book Entry

Press **'PHONEBK'** soft key to enter the phone book

Use ▲ and ▼ to scroll through the phone book until you find the contact you wish to edit

Press **'OPTIONS'** soft key

Use ▲ and ▼ to select **'EDIT'**

The cursor will start to flash on the right hand side of the Number. Modify number using **'CLEAR'** soft key to clear the previous numbers and then enter the correct number(s)

Press **'SAVE'** soft key

PHONE BOOK

The cursor will start to flash on the right hand side of the Name. Modify Name using '**CLEAR**' soft key to clear the previous characters and then enter the correct character(s). Press '**SAVE**' soft key to confirm

Use ▲ and ▼ to select the desired ring tone. Each time you change the tone melody, the phone rings with the selected ring tone and press '**Select**' soft key

Delete a Phone Book Entry

Press '**PHONEBK**' soft key to enter the phone book

Use ▲ and ▼ to scroll through the phone book until you find the contact you wish to delete

Press '**OPTIONS**' soft key

Use ▲ and ▼ to select '**ERASE**' and press '**SELECT**'

Voice Announce a Phonebook Entry

Press '**PHONEBK**' soft key to enter the phone book

Use ▲ and ▼ to scroll through the phone book until you find the contact you wish to edit

Press '**OPTIONS**' soft key to view details of that phone book entry

Choose '**PLAY VOICE**' and press '**SELECT**'. The voice prompt for this entry will be announced. The name will be announced if you have stored a name. However, if no name has been stored, only the telephone number will be announced

PHONE BOOK

Record Voice Announce for a Phonebook Entry

Press **'PHONEBK'** soft key to enter the phone book

Use ▲ and ▼ to scroll through the phone book until you find the contact you wish to edit

Press **'OPTIONS'** soft key

Use ▲ and ▼ to select **'RECORD VOICE'**

Press **'SELECT'** soft key

If you confirm, you can record the name of the phonebook entry (up to 6 seconds). You can also press **'End'** to confirm and end the recording. Your recording will play back for you immediately

Delete Voice Announce for a Phonebook Entry

Press **'PHONEBK'** soft key to enter the phone book

Use ▲ and ▼ to scroll through the phone book until you find the contact you wish to edit

Press **'OPTIONS'** soft key

Use ▲ and ▼ to select **'ERASE VOICE'** and press **'SELECT'**

QUICK DIAL

This telephone has 9 quick dial memory buttons. Six of these buttons are speed dials and the other three are emergency dials. The Emergency buttons are an ideal location to store the doctor or a close friend's number in case of a problem. Once a number has been stored in a memory location, you only need to press one button to make the call.

Create a Quick Dial Number

Enter the telephone number to be stored (maximum of 24 digits). You can edit the number using the '**CLEAR**' soft key

Press and hold the quick dial location to store the telephone number up to '**Number**' will be displayed

'**NUMBER:**' will be displayed

Modify the phone number if it is not correct with the function '**CLEAR**'

Press '**SAVE**' soft key to confirm

'**NAME:**' will be displayed

Enter the name you wish using the numeric keypad

Press '**SAVE**' soft key to confirm

Use ▲ and ▼ to select the desired ring tone. Each time you change the tone melody, the phone rings with the selected ring tone.

Press '**Select**' soft key to confirm

QUICK DIAL

View/Dial a Quick Dial Number

In standby mode, press the required quick dial location.
The telephone number will be displayed

Lift the handset or press  to dial the quick dial
telephone number

Clear a Quick Dial Number

In standby mode, press the required quick dial location.
The telephone number will be displayed

Press '**OPTIONS**' soft key and Use ▲ and ▼ to select
'**ERASE**' and press \. The location will be cleared of the
number. Alternatively, store a new number – this will
automatically erase the previous telephone number

ANSWERING MACHINE

Switching the Answering Machine On/Off

The answering machine can be switched on and off as follows:

Press **'MENU'** soft key

Use **▲** and **▼** to select **'TAM SETUP'**

Press **'SELECT'** soft key

Press **'SELECT'** soft key to select **'TAM ON/OFF'**

Use **▲** and **▼** to select either **'ON'** or **'OFF'** to activate/deactivate the answering machine

Press **'SAVE'** soft key to confirm

When switched to ON position, incoming calls will be answered by the answering machine after a certain number of rings (see Answering Machine Settings). When the answering machine answers an incoming call, the caller will hear your outgoing message. After a short beep they can then leave a message.

If the Answering Machine is OFF, it will answer a call after 10 rings. This is to allow some features to be accessed remotely.

Your CL555 answering machine can be operated from either:

- the telephone unit
- remotely from any external telephone.

ANSWERING MACHINE

Outgoing Message

Before you use the answering machine you should record an outgoing message. The outgoing message is your message to an incoming caller and may be up to 2 minutes in length.

The default OGM is "Please leave your message after the tone". If you prefer, you can record your own OGM.

Recording an Outgoing Message

Press **'MENU'** soft key

Use ▲ and ▼ to select **'TAM SETUP'**

Press **'SELECT'** soft key

Use ▲ and ▼ to select **'OUTGOING MSG'**

Press **'SELECT'** soft key

Use ▲ and ▼ to select **'RECORD OGM'**

Press **'SELECT'** soft key

'RECORDING' will be displayed

On hearing the tone, record your personal OGM. When you have finished speaking press the **'END'** soft key. If you speak for longer than 2 minutes, recording will stop automatically. The new OGM will be played after recording

ANSWERING MACHINE

Checking the Outgoing Message

Press **'MENU'** soft key

Use ▲ and ▼ to select **'TAM SETUP'**

Press **'SELECT'** soft key

Use ▲ and ▼ to select **'OUTGOING MSG'**

Press **'SELECT'** soft key

Press **'SELECT'** soft key to select **'PLAY OGM'**

The current OGM will be played. During the process the display will show **'PLAYING'**. You can press **'END'** soft key to stop and exit.

ANSWERING MACHINE

Restore the Outgoing Message

You can delete your personal recorded OGM and restore the factory default OGM.

Press **'MENU'** soft key

Use ▲ and ▼ to select **'TAM SETUP'**

Press **'SELECT'** soft key

Use ▲ and ▼ to select **'OUTGOING MSG'**

Press **'SELECT'** soft key

STAGE A Use ▲ and ▼ to select **'ERASE OGM'**

Press **'SELECT'** soft key

One beep will be heard

Alternatively, at **STAGE A** you can select the following so as you can toggle between the Default Outgoing Message and the Recorded Outgoing Message

Use ▲ and ▼ to select **'CHANGE OGM'**

Press **'SELECT'** soft key

Use ▲ and ▼ to either **'DEFAULT OGM'** or **'RECORDED OGM'**

ANSWERING MACHINE

Answering Machine Settings

You can select the number of rings before the answering machine is activated and responds to an incoming call. You can choose from the following:

- 2 = calls are answered after two rings
- 3 = calls are answered after three rings
- 4 = calls are answered after four rings
- 5 = calls are answered after five rings
- 6 = calls are answered after six rings
- TS (TOLL SAVER) = activates the toll saver function

In Toll Saver mode incoming calls are answered after five rings until the first new message has been recorded. Once a message has been recorded the answering machine will answer after three rings. This is useful when trying to remotely access the answering machine. If the answering machine has not answered at the fourth ring, no messages have been recorded and you can hang up before you are charged for the call. If the machine answers after three rings, new messages have been recorded.

Press **'MENU'** soft key

Use ▲ and ▼ to select **'TAM SETUP'**

Press **'SELECT'** soft key

Use ▲ and ▼ to select **'RING NUMBER'**

Press **'SELECT'** soft key

Use ▲ and ▼ to select either **'2 RINGS'**, **'3 RINGS'**, **'4 RINGS'**, **'5 RINGS'**, **'6 RINGS'** or **'TOLL SAVER'**

Press **'SAVE'** soft key

ANSWERING MACHINE

Listening to Messages

If you have a new message the display will show how many new messages have been received and new message LED will be lit.

To play the messages through the speaker, press  key. The telephone will announce, "You have N new messages" or "You have N old messages". The messages will be played one by one. During playback, you can do the following:

Press  to delete the current message

Press  once to re-play the current message

Press  twice to re-play the previous message

Press  to play the next message

Press  to stop the playing and exit

To adjust the playback volume use VOL+ or VOL- on the right side of the telephone.

When playback is finished the machine will return to standby mode. All incoming messages are saved (unless you have erased any during playback, see above), new messages will then be recorded after the old ones.

Call Screening

Incoming messages can be heard through the Speakerphone as they are received. If there is no sound, adjust the volume using the control on the right hand side of the telephone. If you want to speak to the caller, lift the handset.

ANSWERING MACHINE

Incoming Message Voice Slow

If you are struggling to hear or understand the message left by a caller, you can play it back in a slow mode.

Press **'MENU'** soft key

Use ▲ and ▼ to select **'TAM SETUP'**

Press **'SELECT'** soft key

Use ▲ and ▼ to select **'ICM VOICE SLOW'**

Press **'SELECT'** soft key

Use ▲ and ▼ to select either **'ON'**, or **'OFF'**

Press **'SELECT'** soft key

Operating the Answering Machine Remotely

This answering machine can be accessed remotely using the keys of an ordinary tone dialling telephone.

Remote Code

A confidential four digit code is required to listen to your messages from a remote external telephone. The default remote code is **0000**. For security reasons it is advisable to change this code.

Press **'MENU'** soft key

Use ▲ and ▼ to select **'TAM SETUP'**

Press **'SELECT'** soft key

Use ▲ and ▼ to select **'SECURITY ID'**

ANSWERING MACHINE

Press 'SELECT' soft key

The current remote code will be displayed on the LCD.
Enter the new code that you wish to use

Press 'SAVE' soft key

Remote Control

Call the answering machine (using your telephone number)

While the outgoing message is playing, press on * key and enter the remote code

If the remote code is accepted, the system will play the menu of commands. You can then follow the voice prompt to operate

When you have finished accessing the machine replace the handset.



Remote Control Commands

Command Functions	
2	Play new messages
2 twice	Stop playback
0	Erase single message during playback
1	Review
3	Skip to next message
4	Switch the answering machine on/off
7	Repeat the menu again

ANSWERING MACHINE

Recording a Memo

You can leave a memo for other answering machine users (up to 3 minutes).

To record the memo, press and hold the  key in standby mode. The display will show 'RECORDING MEMO' and start the recording. The  key should be pressed and held down whilst recording. Release the  key to end the recording.

The message can be played by pressing  of the answering machine or via the remote access function using a normal telephone.

Out of Memory

The total capacity of the answering machine's memory is approximately 40-50 minutes. The memory space is shared between the outgoing message, personal memos, and regular incoming messages. The answering machine will answer after 10 rings to allow remote playback and deletion of messages, no new messages will be accepted until the existing messages have been played and erased.

TROUBLESHOOTING

No display

- Make sure that the power adaptor is plugged in correctly and is not damaged
- Check for a power cut in the area

CL555 does not ring

- Make sure that the telephone line cord is plugged in correctly and is not damaged
- Connect another telephone to the telephone PTT socket or move your telephone to another socket to track if the failure is coming from your telephone or your PTT socket
- There may be too many communication devices connected to a single telephone line e.g. another telephone, modem or facsimile machine. Contact your network provider for help in calculating the limit for your home or business line
- Check the Ringer is not switched to OFF
- Check the Volume level of the ringer

No dial tone

- Make sure that the telephone line cord is plugged in correctly and is not damaged
- Connect another telephone to the telephone PTT socket or move your telephone to another socket to track if the failure is coming from your telephone or your PTT socket
- There may be too many communication devices connected to a single telephone line e.g. another telephone, modem or facsimile machine. Contact your network provider for help in calculating the limit for your home or business line
- Check that the dialing mode is set to the correct setting (tone or pulse)

Interference on the line

- Ensure a filter is fitted to all telephone sockets if you have a DSL line

No Caller ID information displayed

- Ensure you have requested the Caller ID service from your network provider

No Amplification

- Check the Amplify key has been pressed and the LED is lit (red).

SAFETY INFORMATION

General

Only use the power supply included with the product.

Do not open the unit. Contact the helpline for all repairs.

The phone is capable of amplifying sounds to a loud volume. It is important to instruct all potential users of its proper operation. It is advised to adjust the volume control to its minimum level (Low) when not in use and alert other users that hearing damage can potentially result from misuse.

Cleaning

Clean the telephone with a soft cloth. Never use polishes or cleaning agents - they could damage the finish or the electrics inside.

Environmental

Do not expose to direct sunlight.

Always ensure there is a free flow of air over the surfaces of the telephone.

Do not place any part of your product in water and do not use it in damp or humid conditions e.g. bathrooms.

Do not expose your product to fire or other hazardous conditions.

Unplug your phone from the telephone socket during thunderstorms because it could damage your telephone. Your guarantee does not cover thunderstorm damage.

The telephone is designed for working within a temperature range of 5°C to 45°C.

GUARANTEE

From the moment your Geemarc product is purchased, Geemarc guarantee it for the period of two years. During this time, all repairs or replacements (at our discretion) are free of charge. Should you experience a problem then contact our help line or visit our website at **www.geemarc.com**. The guarantee does not cover accidents, negligence or breakages to any parts. The product must not be tampered with or taken apart by anyone who is not an authorized Geemarc representative. The Geemarc guarantee in no way limits your legal rights.

IMPORTANT: YOUR RECEIPT IS PART OF YOUR GUARANTEE AND MUST BE RETAINED AND PRODUCED IN THE EVENT OF A WARRANTY CLAIM.

Please note: The guarantee applies to
the United Kingdom only

DECLARATION: Geemarc Telecom SA hereby declares that this product is in compliance with the essential requirements and other relevant provisions of the Radio and Telecommunications Terminal Equipment Directive 2014/53/UE and in particular article 3 section 1a, 1b and section 2. The telephone does not operate if the line current is lower than 18 mA.

The declaration of conformity may be consulted at www.geemarc.com



GUARANTEE

Electrical connection: The apparatus is designed to operate from a 230V 50Hz supply only. (Classified as 'hazardous voltage' according to EN60950 standard). The apparatus does not incorporate an integral power on/off switch. To disconnect the power, either switch off supply at the mains power socket or unplug the AC adaptor. When installing the apparatus, ensure that the mains power socket is readily accessible.

Telephone connection: Voltages present on the telecommunication network are classified TNV-3 (Telecommunication Network Voltage) according to the EN60950 standard.

RECYCLING DIRECTIVES

The WEEE (Waste Electrical and Electronic Equipment) has been put in place for the products at the end of their useful life are recycled in the best way.

When this product is finished with, please do not put it in your domestic waste bin.

Please use one of the following disposal options:

- Remove the batteries and deposit them in an appropriate WEEE skip. Deposit the product in an appropriate WEEE skip.
- Or, hand the old product to the retailer. If you purchase a new one, they should accept it.

Thus if you respect these instructions you ensure human health and environmental protection.



For product support and help visit our website at

www.geemarc.com

telephone **01707 387602**

or fax **01707 832529**



UGCL555_En_v1.4

geemarc™ UNITED KINGDOM
Telecom SA

5B Swallow Court
Swallowfields
Welwyn Garden City
Hertfordshire, AL7 1SB
For product support:
01707 387602

www.geemarc.com